

M51722P,FP

F-V CONVERTER WITH MULTIPLEXER

80C 08982 DT-73-13-03

6249826 MITSUBISHI ELEK (LINEAR)

DESCRIPTION

The M51722P,FP are semiconductor integrated circuits developed for frequency-voltage (F-V) converter.

In combination with predriver ICs, the devices constitute high-accuracy 2-phase, 3-phase, F-servo motor control system.

FEATURES

- Built-in frequency multiplexer controls motors with high accuracy.
- Operates at a low supply voltage (supply voltage range 4.5~10V)
- Built-in FG amplifier circuit enables operation by weak signals
- Large final stage output current (current source and current sink)

APPLICATION

VTRs, floppy-disk drive, etc.

RECOMMENDED OPERATING CONDITIONS

Supply voltage range 4.5~10V
 Rated supply voltage 9V

PIN CONFIGURATION (TOP VIEW)

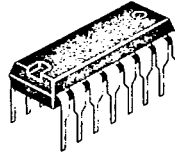
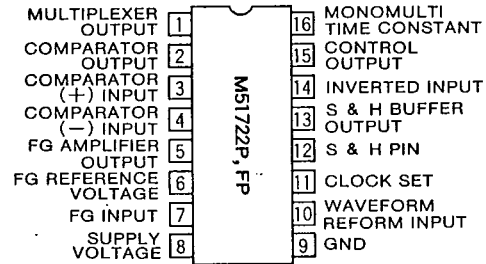

16-pin molded plastic DIP



16-pin molded plastic FLAT (C type)

BLOCK DIAGRAM

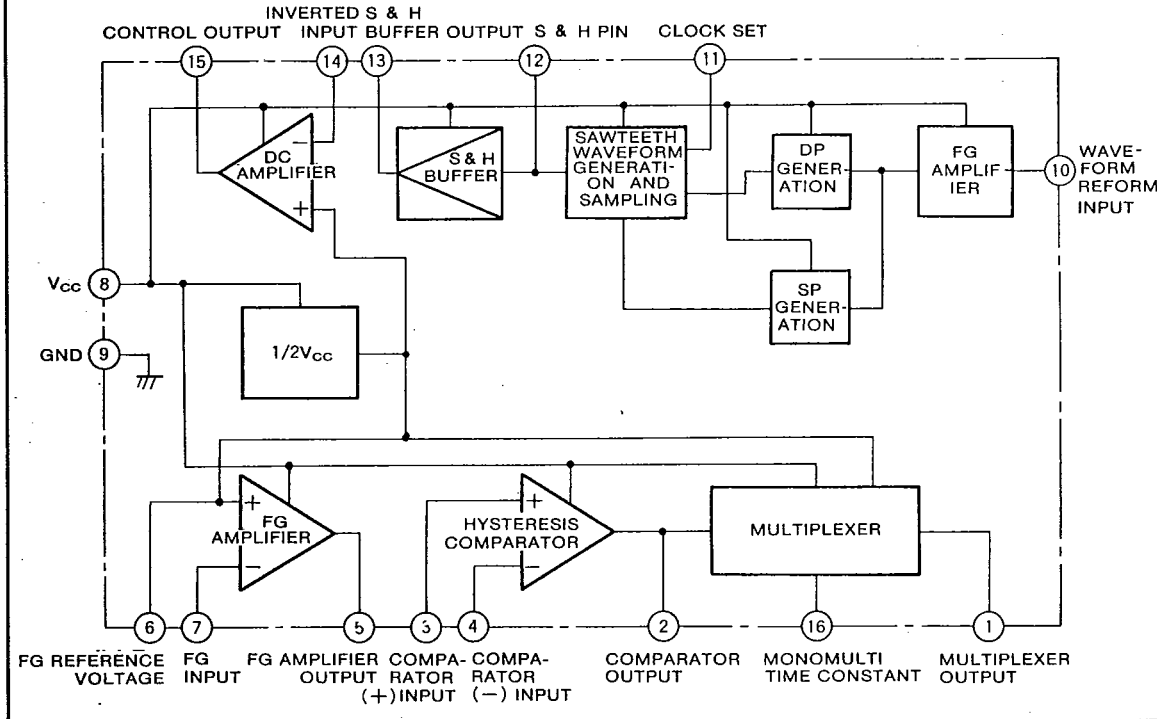

M51722P,FP

F-V CONVERTER WITH MULTIPLEXER

80C 08983 D 7-73-13-03

6249826 MITSUBISHI ELEK (LINEAR)

ABSOLUTE MAXIMUM RATINGS ($T_a=25^\circ\text{C}$, unless otherwise noted)

Symbol	Parameter	Conditions	Ratings	Unit
V_{CC}	Supply voltage		10	V
I_{O2}	Pin ② output current		8	mA
I_{O5}	Pin ⑤ output current		2	mA
I_{O1}	Pin ① source current		8	mA
I_{O5}	Pin ⑤ sink current		12	mA
I_{O13}	Pin ⑬ output current		1	mA
V_{O7}	Pin ⑦ input voltage		$1.5 \sim V_{CC}$	V
V_{O4}	Pin ④ input voltage		$0 \sim V_{CC}$	V
P_{DF}	Power dissipation		770(430)	mW
K_θ	Thermal derating		7.7(4.3)	mW/°C
T_{opr}	Operating temperature		$-20 \sim +75$	°C
T_{stg}	Storage temperature		$-40 \sim +125$	°C

Note: () = M51722FP

ELECTRICAL CHARACTERISTICS ($T_a=25^\circ\text{C}$, $V_{CC}=9\text{V}$, unless otherwise noted)

Symbol	Parameter	Test conditions	Limits			Unit
			Min	Typ	Max	
$I_{CC(1)}$	Circuit current (1)	$V_{CC}=4.5\text{V}$		4.5	9	mA
$I_{CC(2)}$	Circuit current (2)	$V_{CC}=10\text{V}$		4.5	9	mA
$V_{ref(1)}$	Reference voltage of output voltage (1)	Pin ⑥ Open	4.4	4.5	4.6	V
$V_{ref(2)}$	Reference voltage of output voltage (2)	10k Ω between pin ⑥ and GND	4.4	4.5	4.6	V
V_{OH5}	Pin ⑤ high-level output	3.9k Ω between pin ⑤ and GND	6.0	6.8		V
V_{OL5}	Pin ⑤ low-level output	3.9k Ω between V_{CC} and pin ⑤		1.0	1.5	V
V_{OH2}	Pin ② high-level output	2k Ω between pin ② and GND	7.5	8.0		V
V_{OL2}	Pin ② low-level output	2k Ω between V_{CC} and pin ②		1.0	1.5	V
V_{OH13}	Pin ⑬ high-level output	1.5k Ω between pin ⑬ and GND	6.6	7.5		V
V_{OL13}	Pin ⑬ low-level output	1.5k Ω between V_{CC} and pin ⑬		1.0	1.5	V
$V_{offset(6-7)}$	Pin ⑥ - pin ⑦ offset voltage				± 6	mV
$V_{offset(3-4)}$	Pin ③ - pin ④ offset voltage				± 6	mV
$V_{offset(12-13)}$	Pin ⑫ - pin ⑬ offset voltage				± 6	mV
T_{D1}	Pin ① pulse width	Pin ⑬ time constant 100k Ω + 820pF	45	55	65	μs

M51722P,FP

6249826 MITSUBISHI ELEK (LINEAR)

80C 08984

D T-73-13-03

F-V CONVERTER WITH MULTIPLEXER

THERMAL DERATING (MAXIMUM RATING) ($T_a=25^\circ\text{C}$, unless otherwise noted)

M51722P

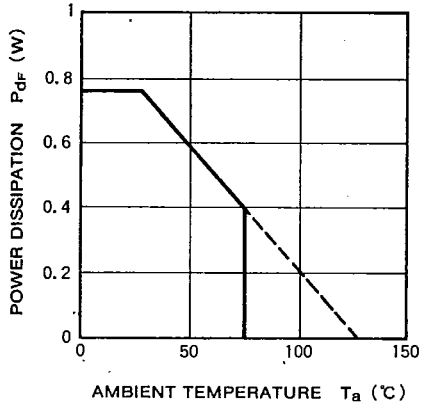

M51722FP

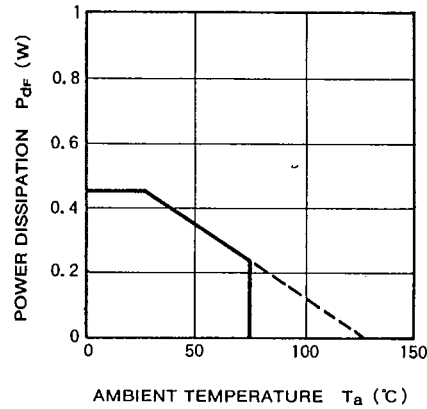

APPLICATION EXAMPLE

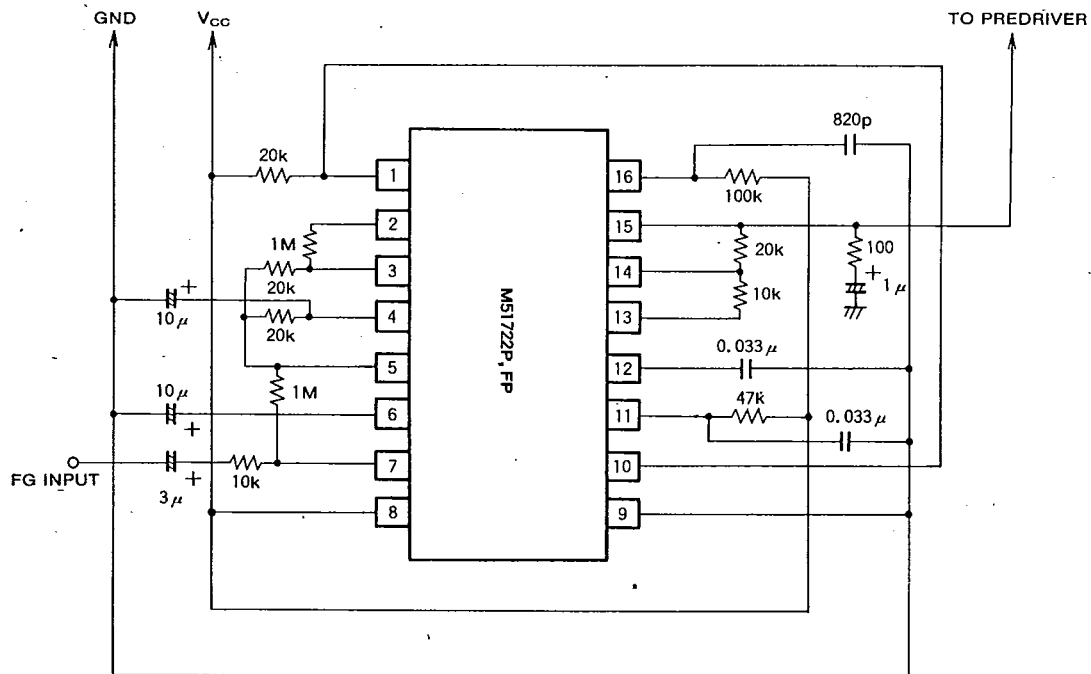

Unit Resistance : Ω
Capacitance : F

F-V CONVERTER WITH MULTIPLEXER

6249826 MITSUBISHI ELEK (LINEAR)

80C 08985

D7-73-13-03

TYPICAL CHARACTERISTICS ($T_a=25^\circ\text{C}$, unless otherwise noted)

CIRCUIT CURRENT VS. SUPPLY VOLTAGE

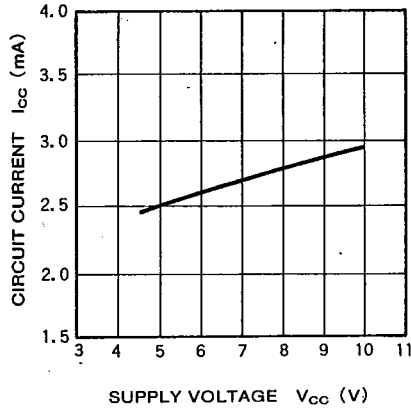

REFERENCE VOLTAGE VS. SUPPLY VOLTAGE

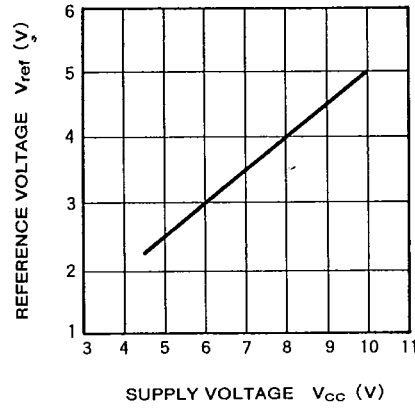

PIN ② SOURCE CURRENT VS. SUPPLY VOLTAGE

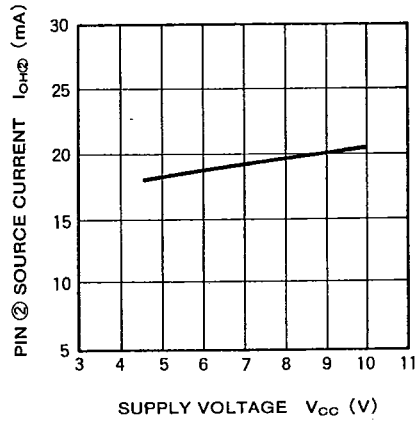

PIN ⑤ SOURCE CURRENT VS. SUPPLY VOLTAGE

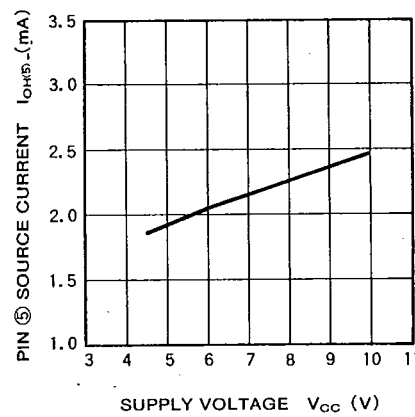

PIN ⑬ SOURCE CURRENT VS. SUPPLY VOLTAGE

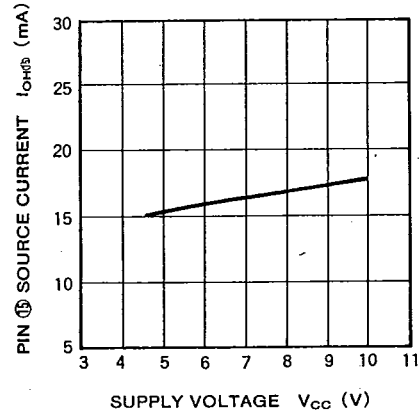

F-V CONVERTER WITH MULTIPLEXER

6249826 MITSUBISHI ELEK (LINEAR)

80C 08986 D 7-73-13-03

CIRCUIT CURRENT VS. AMBIENT TEMPERATURE

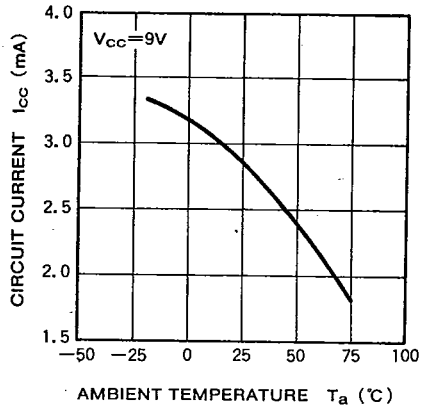

PIN ② SOURCE CURRENT VS. AMBIENT TEMPERATURE

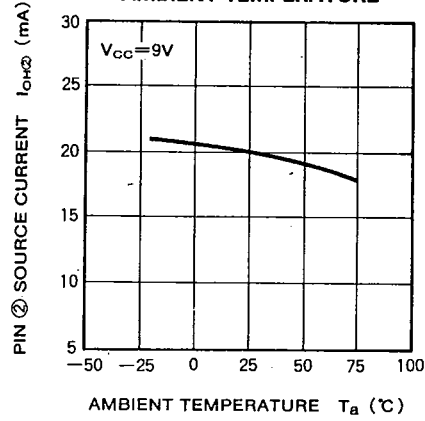

PIN ③ SOURCE CURRENT VS. AMBIENT TEMPERATURE

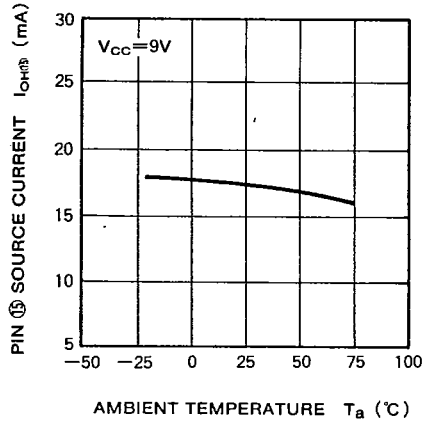

REFERENCE VOLTAGE VS. AMBIENT TEMPERATURE

